

Article number: 3902210015355

Description: Worm gear
VF 210-V-15-160B5, without lubrication

Measures

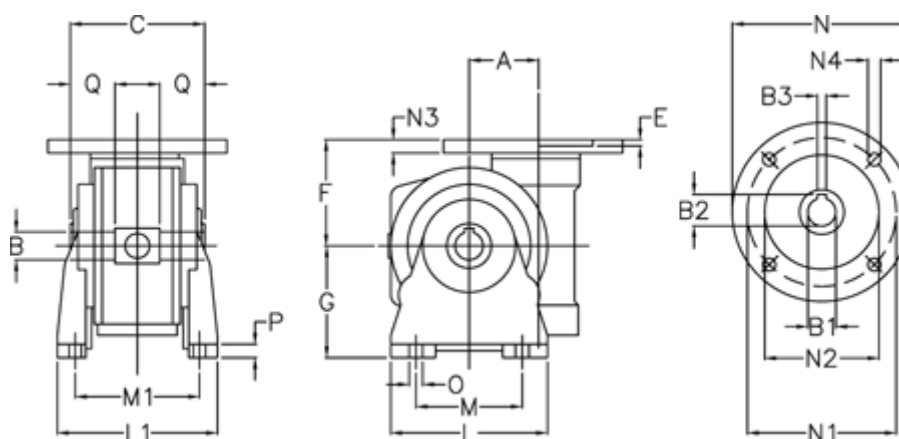

A	= 210	G	= 335	N3	= 22
B	= 90 H7	L	= 440	N4	= 18
B1 E7	= 42	L1	= 320	O	= 26
B2	= 45.3	M	= 340	P	= 25
B3 H9	= 12	M1	= 265	Q	= 85
C	= 260	N	= 350		
E	= 8	N1	= 300		
F	= 460	N2	= 250		